

Model: D8SJ-600 X

Data

Type: Semi-hermetic piston compressors

Producer: Copeland

Series: S

Model: D8SJ-600 X

Technical data

Cylinder count:	8
Displacement [m ³ /h]:	181
Weight [kg]:	367
Oil charge [dm ³]:	7,7
Max. operating current [A]:	107
Locked rotor current [A]:	544
Power supply [V/~/Hz]:	400V/3/50Hz

Connections

	<u>milimeters</u>	<u>inches</u>
Suction line:		3 1/8"
Discharge line:		1 5/8"

Model: D8SJ-600 X

Capacity

R22

Cooling capacity [kW]

$t_c \setminus t_e$	-25	-20	-15	-10	-5	0	5	10
10	69.54	87.92	109.42	134.41	163.28	196.42	-	-
15	64.04	81.92	102.74	126.89	154.75	186.71	-	-
20	58.59	75.95	96.08	119.37	146.21	176.97	212.05	-
25	53.28	70.09	89.52	111.93	137.72	167.27	200.97	239.19
30	48.15	64.41	83.11	104.63	129.35	157.67	189.97	226.63
35	43.29	58.97	76.92	97.53	121.18	148.25	179.13	214.20
40	38.76	53.84	71.03	90.71	113.26	139.06	168.51	201.98
45	34.63	49.10	65.51	84.24	105.67	130.19	158.18	190.03
50	30.97	44.81	60.43	78.19	98.48	121.70	148.22	178.43
55	-	-	55.84	72.62	91.76	113.66	138.69	167.24
60	-	-	-	67.61	85.58	106.14	129.66	156.53

Power input [kW]

$t_c \setminus t_e$	-25	-20	-15	-10	-5	0	5	10
10	19.97	20.99	21.50	21.41	20.60	18.98	-	-
15	21.28	22.75	23.77	24.26	24.10	23.19	-	-
20	22.38	24.27	25.78	26.81	27.27	27.04	26.03	-
25	23.32	25.59	27.56	29.12	30.17	30.60	30.31	29.20
30	24.13	26.77	29.17	31.22	32.83	33.89	34.29	33.94
35	24.87	27.85	30.64	33.16	35.30	36.96	38.03	38.41
40	25.58	28.86	32.03	34.99	37.64	39.86	41.57	42.65
45	26.31	29.86	33.38	36.75	39.87	42.64	44.96	46.71
50	27.09	30.90	34.73	38.48	42.05	45.33	48.23	50.64
55	-	-	36.13	40.23	44.22	47.99	51.44	54.47
60	-	-	-	42.05	46.43	50.66	54.63	58.25

Model: D8SJ-600 X

Capacity

Current [A]

$t_c \setminus t_e$	-25	-20	-15	-10	-5	0	5	10
10	53.02	54.62	55.63	55.88	55.19	53.39	-	-
15	54.93	56.88	58.35	59.16	59.14	58.12	-	-
20	56.54	58.84	60.77	62.16	62.82	62.59	61.28	-
25	57.89	60.56	62.96	64.93	66.28	66.85	66.45	64.91
30	59.04	62.07	64.96	67.51	69.57	70.94	71.46	70.95
35	60.02	63.44	66.81	69.97	72.72	74.91	76.36	76.88
40	60.89	64.70	68.57	72.33	75.80	78.82	81.19	82.76
45	61.69	65.89	70.27	74.65	78.85	82.69	86.01	88.63
50	62.47	67.08	71.97	76.97	81.90	86.59	90.86	94.54
55	-	-	73.71	79.34	85.02	90.56	95.79	100.53
60	-	-	-	81.82	88.24	94.64	100.84	106.66

Mass flow [kg/s]

$t_c \setminus t_e$	-25	-20	-15	-10	-5	0	5	10
10	1 264.69	1 606.28	1 991.96	2 428.78	2 923.78	3 483.99	-	-
15	1 217.17	1 559.29	1 944.70	2 380.46	2 873.59	3 431.15	-	-
20	1 161.69	1 503.83	1 888.48	2 322.67	2 813.45	3 367.85	3 992.92	-
25	1 101.01	1 442.69	1 826.08	2 258.22	2 746.15	3 296.90	3 917.53	4 615.07
30	1 037.95	1 378.67	1 760.30	2 189.89	2 674.47	3 221.08	3 836.77	4 528.58
35	975.28	1 314.55	1 693.93	2 120.47	2 601.21	3 143.18	3 753.44	4 439.02
40	915.80	1 253.12	1 629.75	2 052.75	2 529.15	3 066.00	3 670.33	4 349.18
45	862.31	1 197.17	1 570.57	1 989.53	2 461.10	2 992.31	3 590.22	4 261.85
50	817.58	1 149.50	1 519.16	1 933.59	2 399.83	2 924.92	3 515.91	4 179.83
55	-	-	1 478.32	1 887.72	2 348.14	2 866.61	3 450.18	4 105.89
60	-	-	-	1 854.72	2 308.81	2 820.17	3 395.84	4 042.84

Model: D8SJ-600 X

Capacity

C.O.P. [W/W]

$t_c \setminus t_e$	-25	-20	-15	-10	-5	0	5	10
10	3.48	4.19	5.09	6.28	7.93	10.35	-	-
15	3.01	3.60	4.32	5.23	6.42	8.05	-	-
20	2.62	3.13	3.73	4.45	5.36	6.54	8.15	-
25	2.28	2.74	3.25	3.84	4.57	5.47	6.63	8.19
30	2.00	2.41	2.85	3.35	3.94	4.65	5.54	6.68
35	1.74	2.12	2.51	2.94	3.43	4.01	4.71	5.58
40	1.51	1.87	2.22	2.59	3.01	3.49	4.05	4.74
45	1.32	1.64	1.96	2.29	2.65	3.05	3.52	4.07
50	1.14	1.45	1.74	2.03	2.34	2.68	3.07	3.52
55	-	-	1.55	1.81	2.08	2.37	2.70	3.07
60	-	-	-	1.61	1.84	2.10	2.37	2.69

Application range

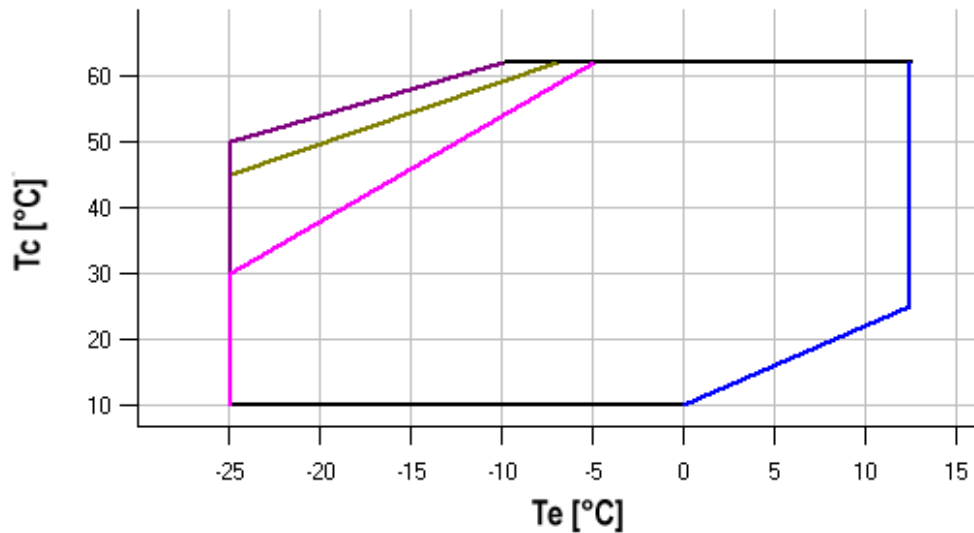

Blue line: Maximum evaporating temperature
Magenta line: 25°C suction gas temperature

Purple line: 10K suction gas return + additional cooling
Olive line: 20K suction gas return

Operating conditions: ISO; subcooling: 0 K, suction superheat: 10 K, return gas temperature: -

t_c - Condensing temperature [°C]

t_e - Evaporating temperature [°C]

Model: D8SJ-600 X

Capacity

R404A/R507

Cooling capacity [kW]

$t_c \setminus t_e$	-35	-30	-25	-20	-15	-10	-5	0	5
30	33.70	44.91	58.24	74.03	92.59	114.27	139.39	168.28	201.27
35	29.74	40.47	53.06	67.84	85.15	105.30	128.63	155.47	186.14
40	-	36.18	47.98	61.70	77.69	96.26	117.75	142.49	170.80
45	-	32.01	42.96	55.59	70.20	87.15	106.75	129.33	155.23
50	-	27.95	38.01	49.47	62.67	77.94	95.60	115.98	139.41
55	-	23.97	33.09	43.35	55.08	68.61	84.28	102.40	123.32

Power input [kW]

$t_c \setminus t_e$	-35	-30	-25	-20	-15	-10	-5	0	5
30	18.39	21.80	25.20	28.51	31.64	34.51	37.03	39.10	40.64
35	18.51	22.19	25.90	29.57	33.11	36.42	39.42	42.03	44.15
40	-	22.47	26.48	30.49	34.40	38.14	41.61	44.73	47.41
45	-	22.67	26.95	31.26	35.54	39.68	43.60	47.21	50.42
50	-	22.79	27.32	31.93	36.54	41.06	45.40	49.48	53.20
55	-	22.86	27.61	32.49	37.41	42.29	47.03	51.56	55.77

Model: D8SJ-600 X

Capacity

Current [A]

t_c \ t_e	-35	-30	-25	-20	-15	-10	-5	0	5
30	52.57	56.34	60.31	64.35	68.28	71.97	75.25	77.98	80.01
35	52.69	56.79	61.16	65.67	70.14	74.44	78.41	81.89	84.75
40	-	57.12	61.87	66.82	71.81	76.69	81.31	85.53	89.18
45	-	57.35	62.45	67.81	73.29	78.73	83.98	88.90	93.32
50	-	57.49	62.90	68.66	74.59	80.57	86.42	92.01	97.17
55	-	57.55	63.26	69.37	75.74	82.22	88.65	94.88	100.76

Mass flow [kg/s]

t_c \ t_e	-35	-30	-25	-20	-15	-10	-5	0	5
30	806.67	1 098.09	1 432.61	1 825.74	2 293.04	2 850.02	3 512.23	4 295.19	5 214.44
35	753.36	1 044.58	1 377.29	1 767.01	2 229.27	2 779.61	3 433.57	4 206.66	5 114.44
40	-	990.94	1 320.49	1 705.46	2 161.35	2 703.72	3 348.08	4 109.98	5 004.95
45	-	936.89	1 261.97	1 640.84	2 089.03	2 622.08	3 255.52	4 004.89	4 885.71
50	-	882.19	1 201.45	1 572.89	2 012.05	2 534.45	3 155.63	3 891.12	4 756.46
55	-	826.58	1 138.69	1 501.37	1 930.15	2 440.56	3 048.15	3 768.43	4 616.96

Model: D8SJ-600 X



Capacity

C.O.P. [W/W]

$t_c \setminus t_e$	-35	-30	-25	-20	-15	-10	-5	0	5
30	1.83	2.06	2.31	2.60	2.93	3.31	3.76	4.30	4.95
35	1.61	1.82	2.05	2.29	2.57	2.89	3.26	3.70	4.22
40	-	1.61	1.81	2.02	2.26	2.52	2.83	3.19	3.60
45	-	1.41	1.59	1.78	1.98	2.20	2.45	2.74	3.08
50	-	1.23	1.39	1.55	1.72	1.90	2.11	2.34	2.62
55	-	1.05	1.20	1.33	1.47	1.62	1.79	1.99	2.21

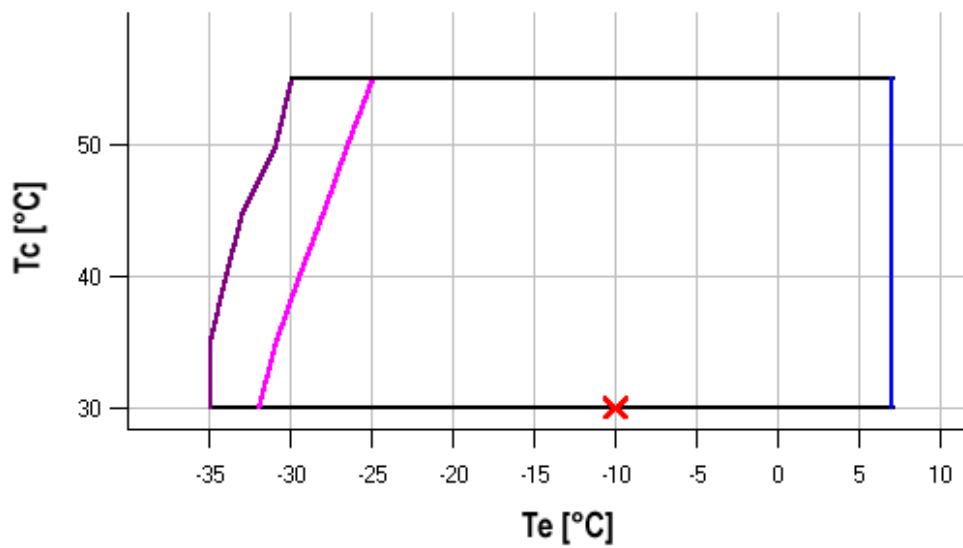
Application range



 Maximum evaporating temperature
 25°C suction gas temperature

 25°C suction gas return + additional cooling

Operating conditions: ISO; subcooling: 0 K, suction superheat: - K, return gas temperature: 20

t_c - Condensing temperature [°C]

t_e - Evaporating temperature [°C]

Model: D8SJ-600 X

Capacity

R407C

Cooling capacity [kW]

$t_c \setminus t_e$	-25	-20	-15	-10	-5	0	5	10
10	57.93	74.26	94.22	118.22	146.66	179.96	-	-
15	55.34	71.39	90.82	114.01	141.39	173.35	210.30	-
20	52.40	68.13	86.97	109.31	135.57	166.15	201.45	241.89
25	49.16	64.52	82.72	104.16	129.25	158.40	192.01	230.49
30	45.66	60.60	78.11	98.61	122.49	150.16	182.03	218.50
35	41.96	56.43	73.21	92.70	115.32	141.47	171.54	205.95
40	38.09	52.04	68.04	86.49	107.80	132.37	160.60	192.91
45	34.11	47.50	62.66	80.02	99.96	122.91	149.25	179.41
50	-	42.83	57.12	73.33	91.87	113.14	137.55	165.50
55	-	-	51.46	66.47	83.55	103.10	125.52	151.22
60	-	-	-	59.50	75.07	92.85	113.23	136.63

Power input [kW]

$t_c \setminus t_e$	-25	-20	-15	-10	-5	0	5	10
10	16.82	18.26	19.18	19.51	19.14	18.00	-	-
15	18.01	19.92	21.35	22.24	22.47	21.97	20.65	-
20	19.03	21.40	23.34	24.78	25.61	25.74	25.10	23.58
25	19.86	22.69	25.13	27.11	28.53	29.30	29.32	28.52
30	20.48	23.76	26.70	29.22	31.22	32.61	33.30	33.21
35	20.88	24.61	28.04	31.09	33.66	35.67	37.02	37.64
40	21.05	25.21	29.12	32.70	35.84	38.46	40.47	41.78
45	20.95	25.55	29.94	34.03	37.73	40.95	43.61	45.61
50	-	25.61	30.47	35.07	39.32	43.15	46.44	49.13
55	-	-	30.69	35.80	40.60	45.02	48.95	52.31
60	-	-	-	36.20	41.54	46.54	51.10	55.14

Model: D8SJ-600 X

Capacity

Current [A]

$t_c \setminus t_e$	-25	-20	-15	-10	-5	0	5	10
10	44.28	45.87	47.17	47.88	47.74	46.45	-	-
15	45.41	47.45	49.30	50.69	51.34	50.96	49.29	-
20	46.52	48.96	51.32	53.34	54.74	55.23	54.54	52.38
25	47.63	50.41	53.24	55.85	57.95	59.26	59.50	58.40
30	48.73	51.81	55.07	58.21	60.97	63.05	64.19	64.09
35	49.83	53.17	56.81	60.44	63.81	66.62	68.60	69.47
40	50.94	54.50	58.46	62.55	66.48	69.98	72.76	74.55
45	52.08	55.80	60.05	64.54	68.99	73.12	76.66	79.32
50	-	57.08	61.56	66.41	71.34	76.06	80.31	83.79
55	-	-	63.02	68.18	73.53	78.81	83.72	87.98
60	-	-	-	69.85	75.59	81.36	86.89	91.90

Mass flow [kg/s]

$t_c \setminus t_e$	-25	-20	-15	-10	-5	0	5	10
10	914.39	1 186.46	1 510.83	1 899.65	2 365.05	2 919.20	-	-
15	899.40	1 175.15	1 501.89	1 891.77	2 356.94	2 909.56	3 561.76	-
20	881.37	1 159.49	1 487.30	1 876.95	2 340.60	2 890.39	3 538.46	4 296.97
25	860.21	1 139.41	1 467.00	1 855.13	2 315.95	2 861.62	3 504.27	4 256.05
30	835.86	1 114.84	1 440.91	1 826.22	2 282.93	2 823.18	3 459.11	4 202.88
35	808.25	1 085.71	1 408.97	1 790.17	2 241.46	2 774.99	3 402.91	4 137.36
40	777.30	1 051.95	1 371.10	1 746.89	2 191.47	2 717.00	3 335.60	4 059.45
45	742.95	1 013.49	1 327.23	1 696.32	2 132.90	2 649.11	3 257.12	3 969.05
50	-	970.26	1 277.30	1 638.38	2 065.66	2 571.27	3 167.37	3 866.11
55	-	-	1 221.22	1 573.01	1 989.69	2 483.41	3 066.31	3 750.55
60	-	-	-	1 500.13	1 904.92	2 385.44	2 953.85	3 622.30

Model: D8SJ-600 X





Capacity

C.O.P. [W/W]

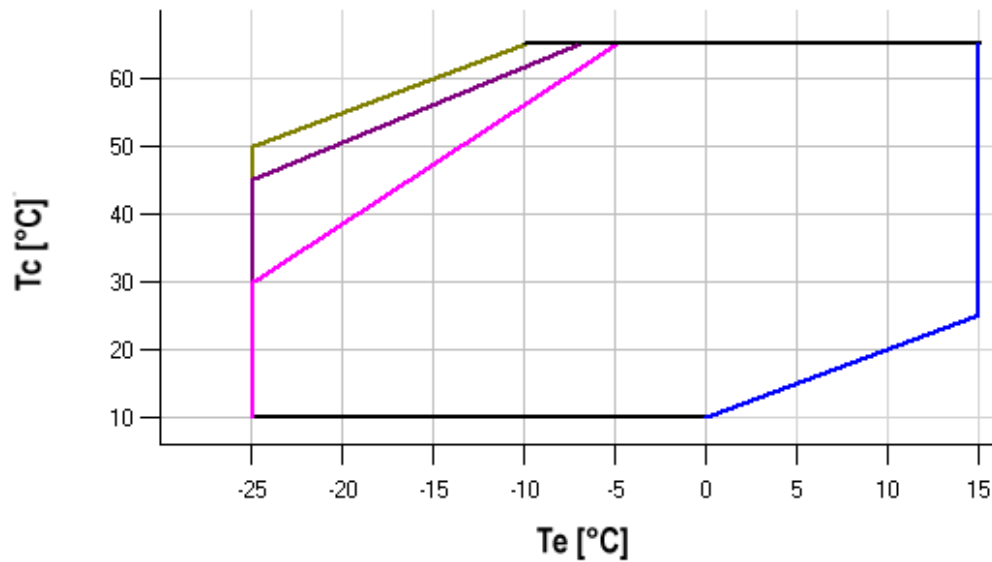
$t_c \setminus t_e$	-25	-20	-15	-10	-5	0	5	10
10	3.44	4.07	4.91	6.06	7.66	10.00	-	-
15	3.07	3.58	4.25	5.13	6.29	7.89	10.19	-
20	2.75	3.18	3.73	4.41	5.29	6.45	8.03	10.26
25	2.48	2.84	3.29	3.84	4.53	5.41	6.55	8.08
30	2.23	2.55	2.93	3.37	3.92	4.60	5.47	6.58
35	2.01	2.29	2.61	2.98	3.43	3.97	4.63	5.47
40	1.81	2.06	2.34	2.65	3.01	3.44	3.97	4.62
45	1.63	1.86	2.09	2.35	2.65	3.00	3.42	3.93
50	-	1.67	1.87	2.09	2.34	2.62	2.96	3.37
55	-	-	1.68	1.86	2.06	2.29	2.56	2.89
60	-	-	-	1.64	1.81	1.99	2.22	2.48

Application range



-  Maximum evaporating temperature
-  25°C suction gas temperature
-  20K suction gas return
-  20K suction gas return + additional cooling

Operating conditions: ISO; subcooling: 0 K, suction superheat: 10 K, return gas temperature: -

t_c - Condensing temperature [°C]

t_e - Evaporating temperature [°C]

Model: D8SJ-600 X

Dimensions

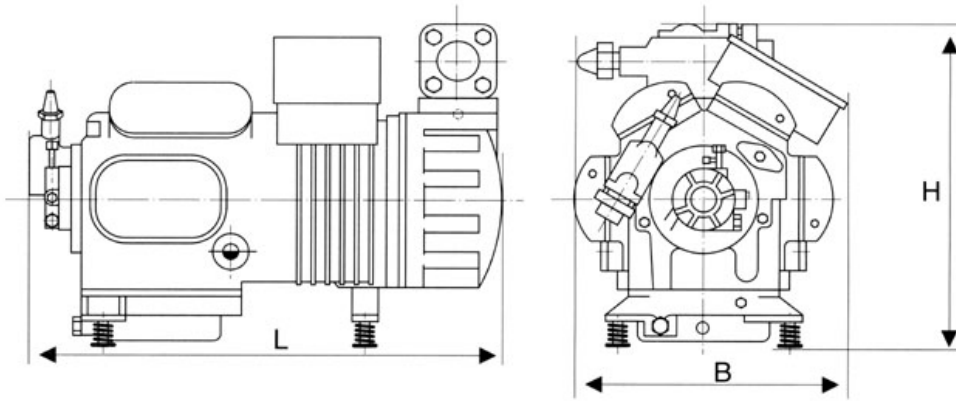

L	835 mm
B	625 mm
H	670 mm

Model: D8SJ-600 X

Image

